

Wechseleinsätze

Inserts

Inserts

easy-quick

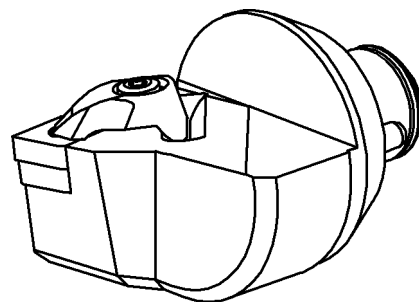
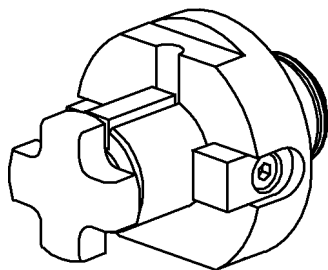
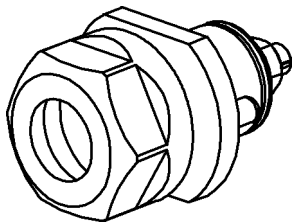
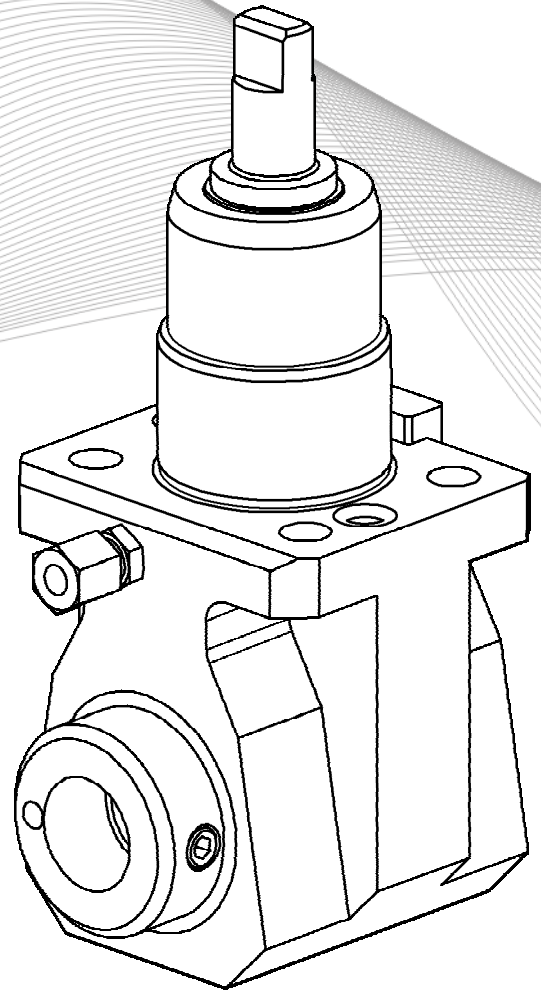

easy-quick

HT 5

Wechseleinsätze für *easy-quick* System

Inserts for *easy-quick* system
Inserts pour *easy-quick* système

Größe HT 5
size HT 5
numéro HT 5

Spannzangenaufnahme

collet chuck

porte pince

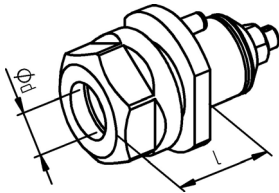

Spannsystem clamping system système de serrage	Bestell-Nr. ref.-no. no. de cde.	Ød [mm]	l [mm]
ER 20	8 779 74 002	0,5 – 13,0	29,0
ER 25	8 779 75 001	0,5 – 16,0	30,0
ER 32	8 779 76 002	1,0 – 20,0	54,0



ZB 655 ...



ZB ER ...



ZB ET ...



ZB 741 ...

Spannzangenaufnahme lang

collet chuck long

porte pince long

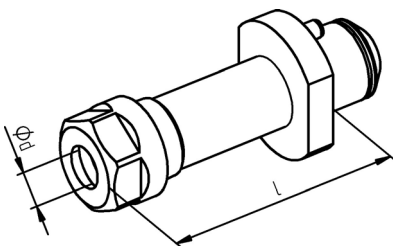

Spannsystem clamping system système de serrage	Bestell-Nr. ref.-no. no. de cde.	Ød [mm]	l [mm]
ER 16	8 779 74 006	0,5 – 10,0	70,0
ER 20	8 779 74 018	0,5 – 13,0	70,0
ER 25	8 779 75 010	0,5 – 16,0	70,0



ZB 655 ...



ZB ER ...



ZB ET ...



ZB 741 ...

Spannzangenaufnahme mit Zugausgleich

collet chuck with
compensation

porte pince avec
compensation

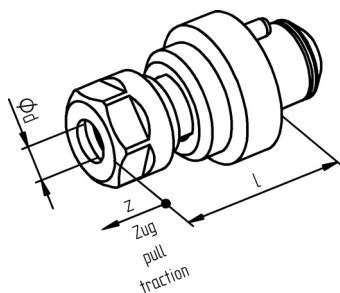

Spannsystem clamping system système de serrage	Bestell-Nr. ref.-no. no. de cde.	Ød [mm]	l [mm]	z [mm]
ER 20	8 779 74 004	0,5 – 13,0	51,0	8,0
ER 25	8 779 75 004	0,5 – 16,0	66,0	8,0



ZB 655 ...



ZB ER ...



ZB 690 ...



Darstellung symbolisch
symbolical drawing
schéma symbolique

ZB HT5 7 000

Wechseleinsätze für *easy-quick* System

Inserts for *easy-quick* system
Inserts pour *easy-quick* système

Größe HT 5
size HT 5
numéro HT 5

Weldon

Weldon

Weldon

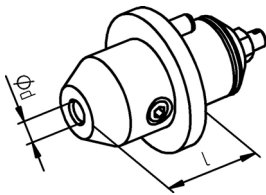

Spannsystem clamping system système de serrage	Bestell-Nr. ref.-no. no. de cde.	Ød [mm]	l [mm]
Weldon / Whistle – Notch 6	8 779 72 000	6	28,0
Weldon / Whistle – Notch 8	8 779 73 000	8	28,0
Weldon / Whistle – Notch 10	8 779 74 001	10	28,0
Weldon / Whistle – Notch 12	8 779 74 000	12	28,0
Weldon / Whistle – Notch 14	8 779 74 005	14	28,0
Weldon / Whistle – Notch 16	8 779 75 000	16	28,0
Weldon / Whistle – Notch 18	8 779 75 002	18	34,0
Weldon / Whistle – Notch 20	8 779 76 001	20	36,0

- weitere Abmessungen ab $\text{ød}=3$ mm auf Anfrage
further dimension from $\text{ød}=3$ mm on request
d'autres dimensions à partir du $\text{ød}=3$ mm sur demande

Weldon lang

Weldon long

Weldon long

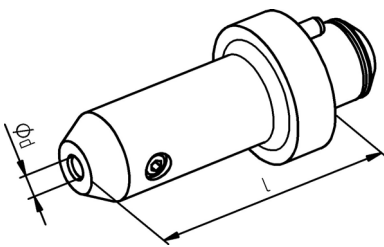

Spannsystem clamping system système de serrage	Bestell-Nr. ref.-no. no. de cde.	Ød [mm]	l [mm]
Weldon / Whistle – Notch 6	8 779 72 001	6	70,0
Weldon / Whistle – Notch 8	8 779 73 001	8	70,0
Weldon / Whistle – Notch 10	8 779 74 007	10	70,0
Weldon / Whistle – Notch 12	8 779 74 008	12	70,0
Weldon / Whistle – Notch 14	8 779 74 017	14	70,0
Weldon / Whistle – Notch 16	8 779 75 009	16	70,0

- weitere Abmessungen ab $\text{ød}=3$ mm auf Anfrage
further dimension from $\text{ød}=3$ mm on request
d'autres dimensions à partir du $\text{ød}=3$ mm sur demande



Darstellung symbolisch
symbolical drawing
schéma symbolique

ZB HT5 7 000

Wechseleinsätze für *easy-quick* System

Inserts for *easy-quick* system
Inserts pour *easy-quick* système

Größe HT 5

size HT 5
numéro HT 5

Schrumpffutter

shrinking chuck

porte outil de frettage

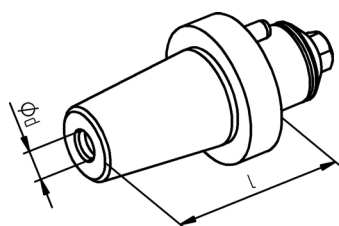

Nenngröße nominal size dimension nominale	Bestell-Nr. ref.-no. no. de cde.	Ød [mm]	l [mm]
6	8 779 72 004	6	40,0
8	8 779 73 003	8	40,0
10	8 779 74 009	10	40,0
12	8 779 74 010	12	45,0
14	8 779 74 019	14	50,0
16	8 779 75 008	16	50,0
18	8 779 75 011	18	50,0
20	8 779 76 004	20	50,0

- weitere Abmessungen ab $\text{Ød}=3$ mm auf Anfrage
further dimension from $\text{Ød}=3$ mm on request
d'autres dimensions à partir du $\text{Ød}=3$ mm sur demande

Fräsdorn

arbor

porte fraise

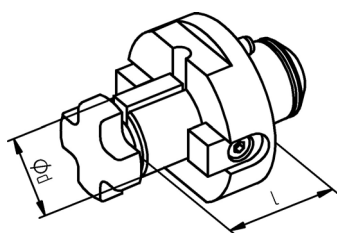

Spannsystem clamping system système de serrage	Bestell-Nr. ref.-no. no. de cde.	Ød [mm]	l [mm]
Kombidorn 16	8 779 74 003	16	14,0
Kombidorn 22	8 779 75 003	22	14,0
Kombidorn 27	8 779 76 005	27	19,0



ZB 655 ...



ZB 620 ...



Darstellung symbolisch
symbolical drawing
schéma symbolique

ZB HT5 7 000

Wechseleinsätze für *easy-quick* System

Inserts for *easy-quick* system
Inserts pour *easy-quick* système

Größe HT 5

size HT 5
numéro HT 5

Prüfdorn

test mandrel

porte outil de contrôle

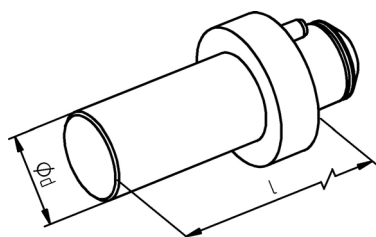

Nenngröße nominal size dimension nominale	Bestell-Nr. ref.-no. no. de cde.	Ød [mm]	l [mm]
30	8 208 77 000	30	150,0

Verschlussstopfen

plug

bouchon de protection

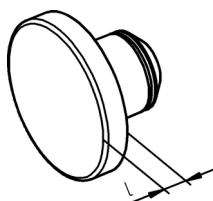

Bestell-Nr. ref.-no. no. de cde.	l [mm]
8 779 79 002	7,0

Rohling

blank

ébauche

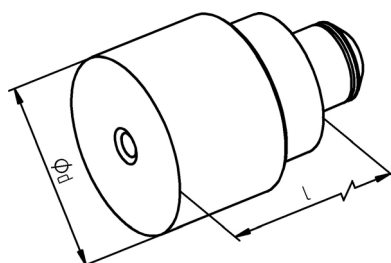

Nenngröße nominal size dimension nominale	Bestell-Nr. ref.-no. no. de cde.	Ød [mm]	l [mm]
63	8 779 79 003	63	140,0



Darstellung symbolisch
symbolical drawing
schéma symbolique

ZB HT5 7 000

Wechseleinsätze für *easy-quick* System

Inserts for *easy-quick* system







Inserts pour *easy-quick* système

Symbolbeschreibung

description of symbol

table des symboles



Symbole symbols symbole	Zubehörblatt accessory sheet accessoires
 ZB 655 ...	Bedienwerkzeuge service tools clés de serrage
 ZB ER ...	Spannzangen ER – DIN 6499 collets ER – DIN 6499 pince de serrage ER – DIN 6499
 ZB ET ...	Gewindebohrzangen ET – DIN 6499 tapping collet ET – DIN 6499 pince de taraudage ET – DIN 6499
 ZB 741 ...	Dichtscheiben sealing disks joints d'étanchéité
 ZB 711 ...	Mitnehmer für Gewindebohrer drivers for tap les entraîneur pour taraud
 ZB 620 ...	Fräsdornringe milling arbor spacers bagues de réglage fraise



easy-quick

- mit anderen Spannsystemen
with other clamping systems
avec d'autres systèmes de serrage
- mit weiteren Aufnahmegrößen
with different size application
autres dimensions possibles
- als Sonderlösung nach Kundenvorgabe
Special solution subject to customer requested specification
en exécution spéciale suivant données client

auf Anfrage
on request
sur demande



Darstellung symbolisch
symbolical drawing
schéma symbolique